

PART No. 1414N4PHSSM6LP

for more information visit
www.hammfg.com

Data subject to change without notice

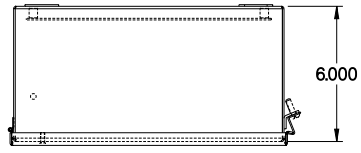

TOP VIEW

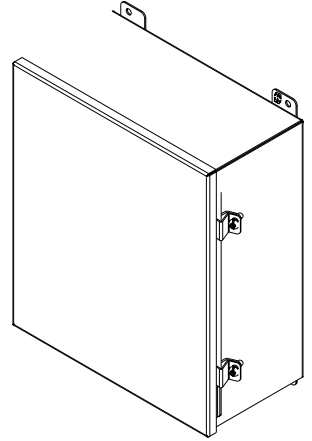

ISOMETRIC VIEW

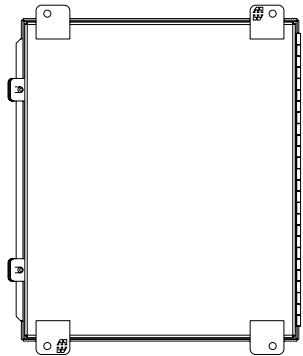

BACK VIEW

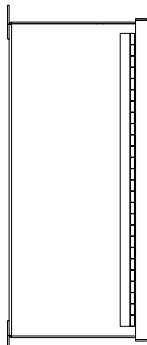

LEFT SIDE VIEW

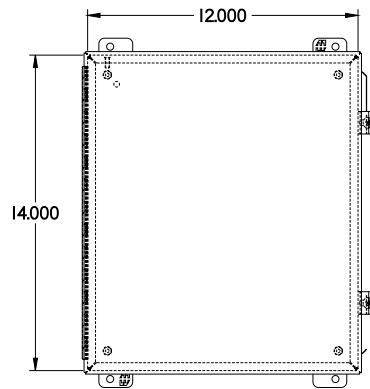

FRONT VIEW

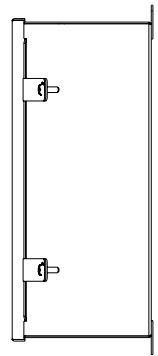

RIGHT SIDE VIEW



BOTTOM VIEW